



381N25K

381 Series Industrial Potentiometer, Conductive Plastic Element, Solder lug Terminals, 1 W Power Rating, 25 kOhm Resistance Value

Representative photograph, actual product appearance may vary.

Due to regional agency approval requirements, some products may not be available in your area.

Please contact your regional Honeywell office regarding your product of choice.

Features

- Conductive plastic element
- Linear taper
- Rugged construction: Metal case and nickel-plated brass shaft and bushings
- Solder lug terminals

Typical Applications

- Manual controls
- Welding and heating
- Telecommunications

Description

The 381 Series is a 1 watt potentiometer with a conductive plastic element and a metal housing.

381N25K

381 Series Industrial Potentiometer, Conductive Plastic Element, Solder lug Terminals, 1 W Power Rating, 25 kOhm Resistance Value

Product Specifications	
Potentiometer Type	Industrial
Element Type	Conductive Plastic
Terminal Type	Solder lug
Power Rating	1 W
Resistance Value	25 kOhm
Resistance Tolerance	± 10 %
Linearity	± 5 %
Bushing Thread	6,35 mm [0.25 in] x 32 NEF-2A
Bushing length	6,35 mm [0.25 in]
Bushing Type	Standard
Shaft Diameter	3,18 mm [0.125 in]
Shaft length	19,05 mm [0.75 in]
Shaft Ending	Slotted
Body	15.88 mm [0.625 in] diameter, ± 0.79 mm [0.031 in]
Electrical Taper	Linear
Operating Temperature	-40 °C to 120 °C [-40 °F to 248 °F]
Working Voltage (Max.)	350 V
Rotational Life	25000 cycles
Mechanical Rotation	300°
Availability	Global
Series Name	381 Series
UNSPSC Code	4111363300
UNSPSC Commodity	4111363300 Potentiometers

Honeywell

381N25K

381 Series Industrial Potentiometer, Conductive Plastic Element, Solder lug Terminals, 1 W Power Rating, 25 kOhm Resistance Value

For Reference Only mm/in

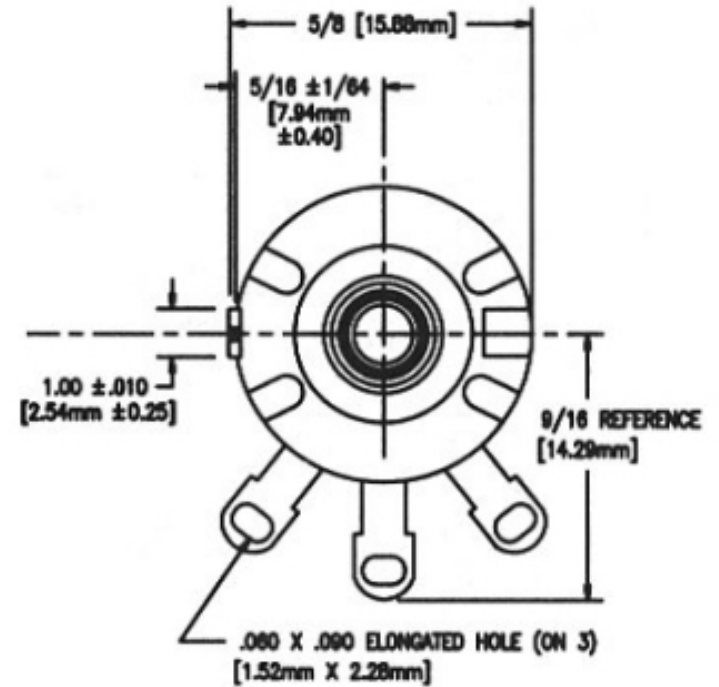
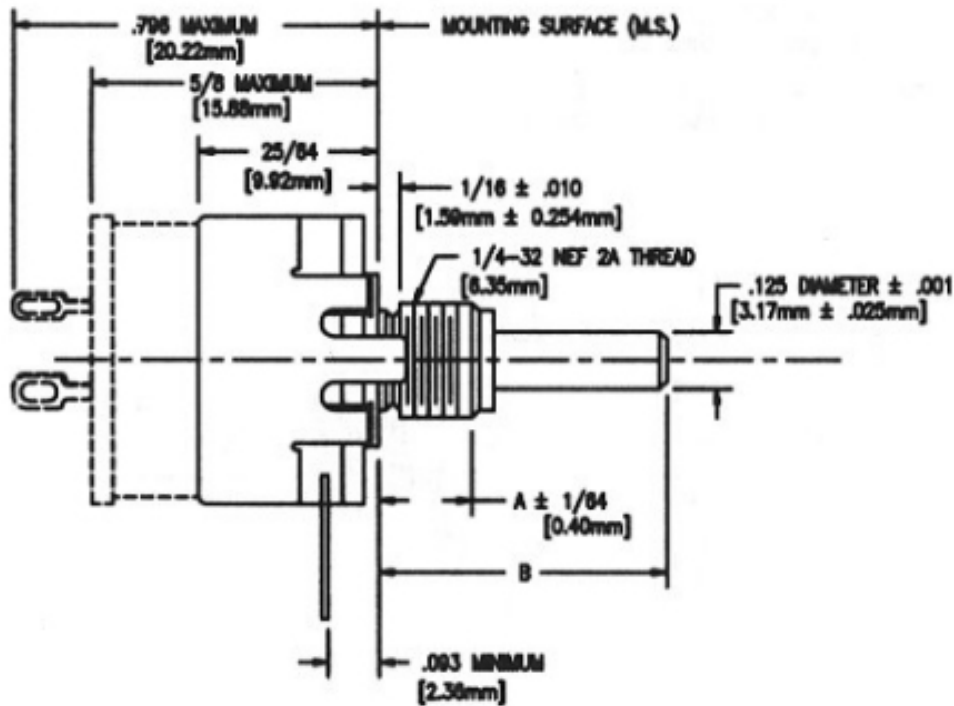

A & B & C DIMENSIONAL VARIABLE. TOLERANCES NOT SPECIFIED $\pm 1/32$ [0.80mm]

Honeywell

381N25K

381 Series Industrial Potentiometer, Conductive Plastic Element, Solder lug Terminals, 1 W Power Rating, 25 kOhm Resistance Value

 WARNING

PERSONAL INJURY

DO NOT USE these products as safety or emergency stop devices, or in any other application where failure of the product could result in personal injury.

Failure to comply with these instructions could result in death or serious injury.

 WARNING

MISUSE OF DOCUMENTATION

- The information presented in this product sheet (or catalog) is for reference only. DO NOT USE this document as product installation information.
- Complete installation, operation and maintenance information is provided in the instructions supplied with each product.

Failure to comply with these instructions could result in death or serious injury.